

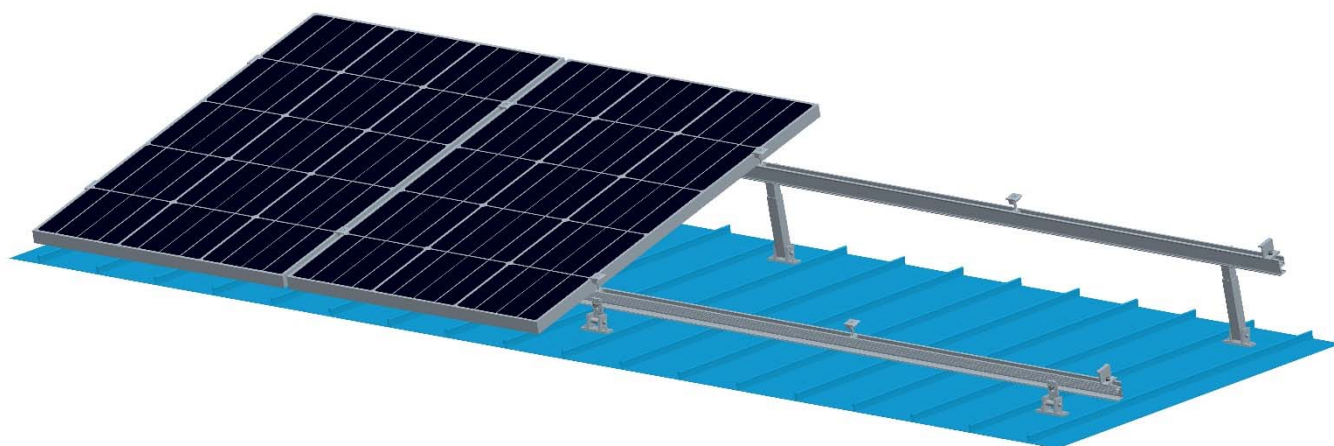

Installation Manual—Rail IV
Solar Mounting System
(Flat Roof Tilted Solution)



Version 2016 1.0

www.antisolar.com

CONTENTS

General Introduction	2
Technical Specification	3
Safety and Installer Responsibilities	4
Components List	5
Before Installing	6
Receipt of Goods	6
Tools Required for Installation	6
Installation Planning	7
Determining Wind Terrain Category	7
Determining Wind Region	8
Planning the Module Area	9
Designing Your Tilt System	10
Determine the Height of The Installation Site.....	11
Verify Acceptable Rail End Overhang	11
Verify Acceptable Rail End Overhang	11
Determine Roof Slope	11
Determine the Maximum Rail Support Spacing.....	11
Installation Instruction	12
Warranty	16
Maintenance and Cleaning	19
References	19
Contact Details	19
Appendixes	19

GENERAL INTRODUCTION

Antaisolar flat roof adjustable tilt mounting system has been developed as a universal PV module mounting system for flat roof or open space ground installation. 10-15, 15-30, 30-60 adjustable degree optional. The innovative and the high degree of pre-assembly eliminate the need for onsite cutting, welding and enables quick and easy field PV module installation.

Rail IV

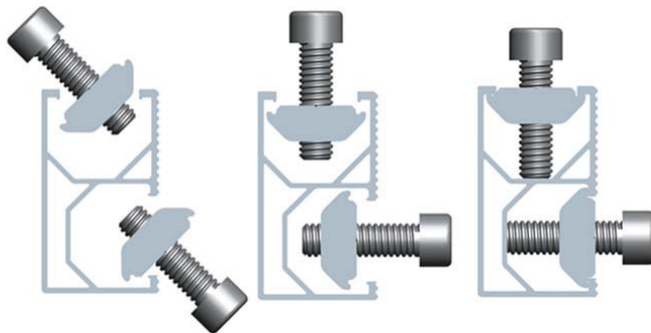

Easy to be installed

Antaisolar features series of highly engineered new innovative product, designed with experienced engineers to the speed of installation.

Antaisolar pitched roof solar mounting system is backed by a 10-year warranty and is compliant with AS/NZS1170.2.2011 Amdt 3 – 2012

Benefits of Antaisolar Flat Roof Mounting System



- Easy Installation
- Diversified Application
- High Accuracy
- Choice Quality
- Engineered to highest standards
- Maximum Lifespan
- Guaranteed durability

TECHNICAL SPECIFICATIONS

Applications

- Commercial and residential buildings
- Marine applications and remote areas

Features

- Anodized 6005-T5 aluminum extrusion
- Innovated designed of the Tilt-in modules, which can be pre-assembly with the clamp, make the installation easy and quick.
- Suitable for difference conditions and the most solar panels at present market.
- Significantly higher strength-to-weight ratio than other framing products, providing improved efficiency due to greater frame spans, inherent corrosion resistance resulting in low ongoing maintenance and an extended product life.
- Complies with Australian/New Zealand Standard on Wind Actions, AS/NZS1170.2.2011 Amdt 3 – 2012
- 10 years limited warranty backed up by parent company Antai Aluminium

Material

Material	Tensile strength	
	Ultimate	Yield
6005 T5 aluminum extruded	260Mpa	240Mpa
Stainless steel 304	625.55Mpa	263.8Mpa
Stainless steel A2-70	700MPa	450Mpa

Installation condition

Roof slope	Up to 60°
Building height	Up to 20m
Mounting structure	Timber/ steel
Roof types	Open Area/Trapezoidal metal sheet/Klip-Lok® roof
System angle	Flush with roof

Note: If the condition is beyond the table list, please contact us to confirm

SAFETY AND INSTALLER RESPONSIBILITIES

Handling and Installing Antaisolar

It is critically important that safety practices are observed when installing

- Do not throw or roughly handle any Antaisolar components.
- Do not bring Antaisolar system into contact with sharp or heavy objects.
- Do not modify Antaisolar components in any way. The exchange of bolts, drilling of holes, bending or any other physical changes not described in standard installation procedure will void the warranty.
- It is the installer's responsibility to verify the integrity of the structure to which Antaisolar components is fixed. Roofs or structures with rotten/rusted bearers, undersized bearers, excessively spaced bearers, or any other unsuitable substructure cannot be used with Antaisolar components, and installation on such structures will void the warranty, and could result in death or serious injury.

Wind and Climate Design







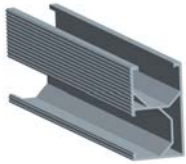

AS/NZS1170.2.2011 provides guidance on determining the wind pressures applicable to your Antaisolar system install site, taking into account roof shape and geographic location. Sufficient guidance is given in this document, but you may wish to procure a copy of these standards if your company installs Australia/New Zealand wide.

- REMEMBER average wind speeds are higher for structures mounted closer to the roof perimeter zone (edge). Refer to 'Fixing within Roof Installation Zone' for more information)
- Make sure your installation complies with local and national building codes. Take into account relevant design parameters (wind speed, exposure and topographic factor) when determining the loading for the installation.
- If alternative fasteners are used to fix the framing to the roof (assuming supplied fasteners are unsuitable for any reason), all screw fasteners must conform to corrosion resistance Class 4 Australian Standard AS3566 and be of equal or greater strength to those supplied with your Antaisolar system order.

CAUTION: INSTALLATION OF THIS PRODUCT IS TO BE PERFORMED ONLY BY PROFESSIONALLY TRAINED INSTALLERS. ANY ATTEMPT BY AN UNQUALIFIED PERSON TO INSTALL THIS PRODUCT COULD RESULT IN DEATH OR SERIOUS INJURY.

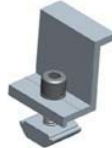
COMPONENTS LIST

Overview of system components

Part name	Picture	Part name	Picture
Rail IV		Rail splice for rail IV	
Front foot		Adjustable rear leg 220mm(10-15deg) 350mm(15-30deg) 600mm(30-60deg)	
Inter Clamp (with T-module)		End Clamp (with T-module)	
T-module		Hexagon socket bolt M8*30/45/50/55/60	
Klamp Lock 700		Klamp Lock 406	





Note: The quantity of requested components depends on the system you ordered.

BEFORE INSTALLING

Receipt of goods

Check that the Antaisolar equipment is undamaged and that the order is complete. Check for correct quantities of the items.

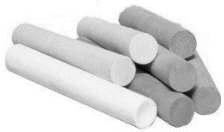
Tools required for installation

<p>6 mm Allen key or hexagonal driver bit. If using a 6mm driver bit, make sure the cordless power tool used for the driving has a hand-tight clutch setting a fine (soft) impact drive to prevent damage to the fragile glass panels and threads on the structure.</p>	
<p>Cordless drill. Drill or impact driver for driving roof material fixings</p>	
<p>Gloves. Protect the hazard of the sharp corners.</p>	
<p>Cord or color pen. Mark the installation position.</p>	
<p>Spirit level</p>	
<p>Measuring tape</p>	

INSTALLATION PLANNING

DETERMINING WIND TERRAIN CATEGORY

Terrain Category 2

Open terrain, including grassland with well scattered obstructions having heights generally from 1.5 meters to 5 meters. Examples include farmland or cleared sub-divisions with isolated trees and uncut grass.

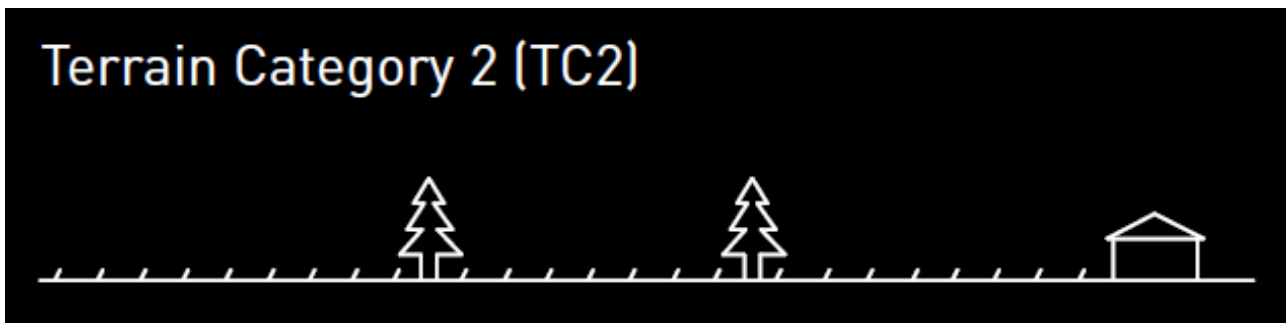

Terrain Category 3

Terrain with numerous closely spaced obstructions having heights generally from 3 meters to 10 meters. Examples include typical suburban housing or light industrial areas.

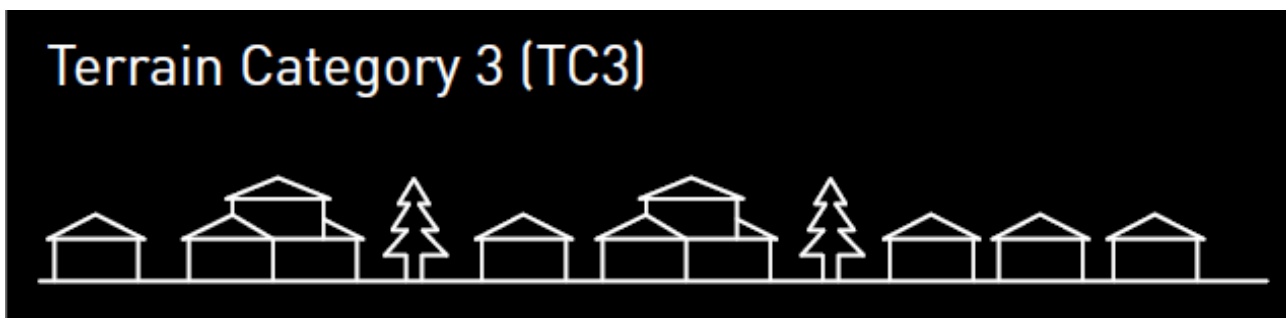

DETERMINING WIND REGION

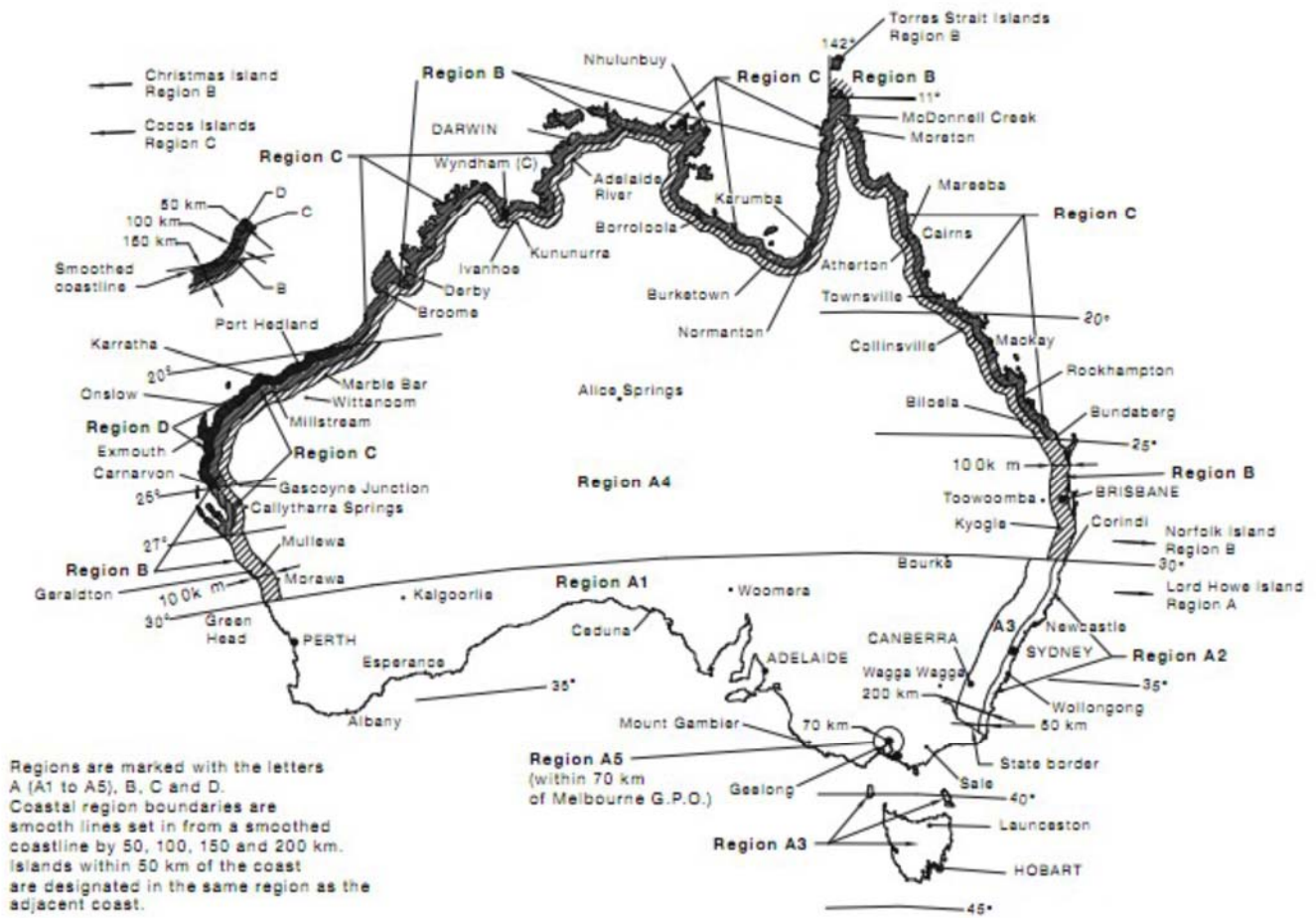

FIGURE 3.1(A) WIND REGIONS

Figure: National wind map (in accordance with AS/NZS 1170.2:2011/Amdt 3:2012)

Wind regions are pre-defined for all of Australia by Australian Standard AS/NZS 1170. The Wind Region has nothing to do with surrounding topography or buildings.

Wind Zone	A	B	C	D
Wind Speed (m/s)	41	48	69	88

Included towns:

Region A:

Callytharra Springs, Gascoyne Junction, Green Head, Kununurra, Lord Howe, Island, Morawa, Toowoomba, Wittanoom, Bourke

Region B:

Adelaide River, Atherton, Biloela, Brisbane, Christmas Island, Collinsville, Corindi, Geraldton, Ivanhoe, Kyogle, Marble Bar, Mullewa, Norfolk Island, Torres Strait Islands, Wyndham

Region C:

Borroloola, Broome, Bundaberg, Burketown, Cairns, Cocos Islands, Darwin, Derby, Karumba, Mackay, Mareeba, Millstream, Moreton, Nhulunbuy, Normanton, Rockhampton, Townsville

Region D:

Carnarvon, Exmouth, Karratha, Onslow, Port Hedland

PLANNING THE MODULE AREA

Solar panels can be installed anywhere on the roof, as long as sufficient fixings are used. Higher wind speeds are encountered at the edges of roofs and therefore more fixings are required in these areas. For a tilted array, a roof can be divided into three zones, the internal zone, intermediate zone and the edge zone. The width of these outer zones can be determined based on the length, width and average height of the building. If fixings are located in the intermediate, edge or end zones, then the maximum spacing to the next fixing must be reduced, as per the table in the certifications.

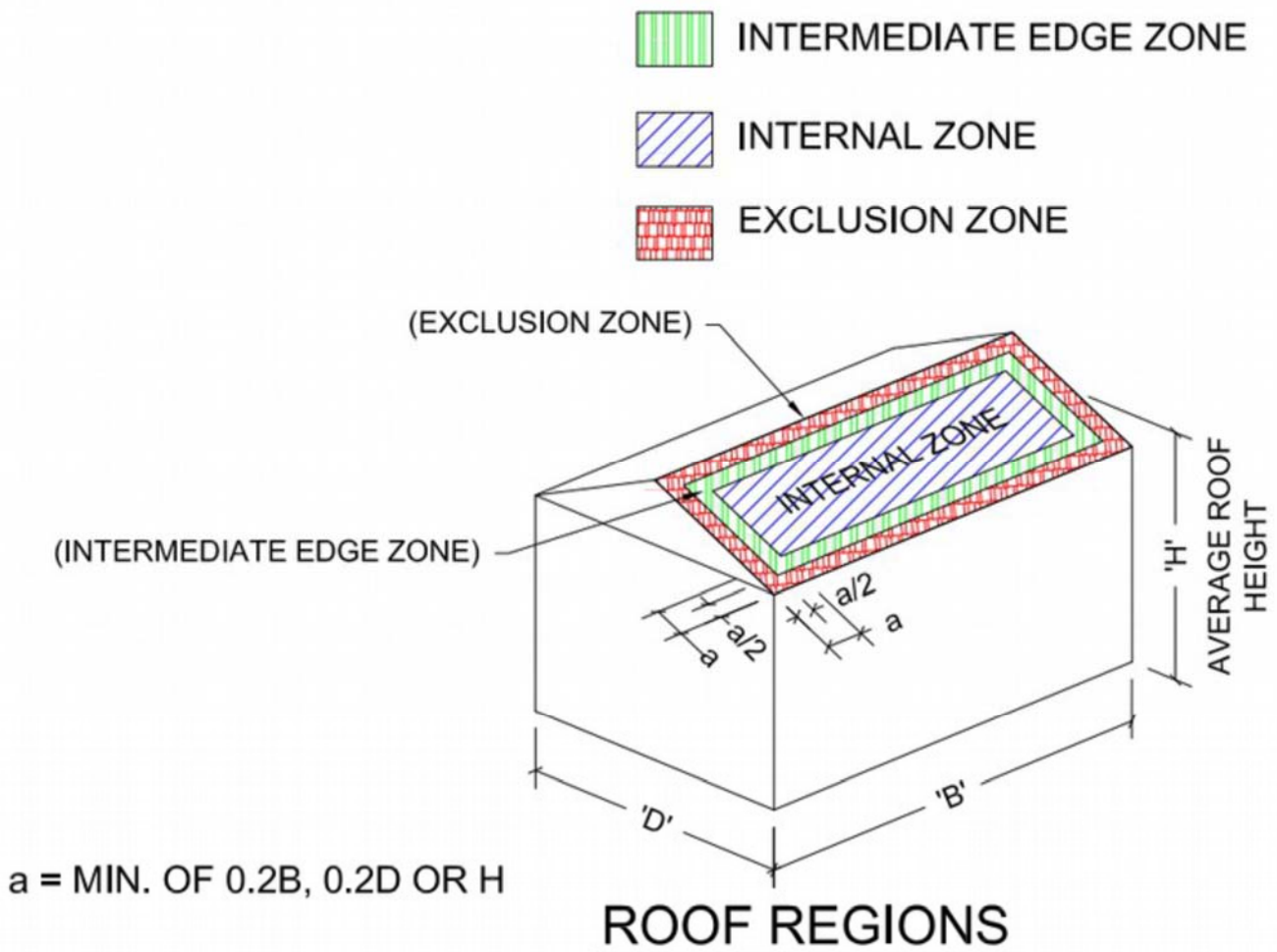

Determining the width of the edge and intermediate zones, 'A' the width of the edge and intermediate zones, 'A', is determined by calculating each of the following values, and then using the smallest:
 $0.2 \times B$, $0.2 \times D/H$

DESIGNING YOUR TILT SYSTEM

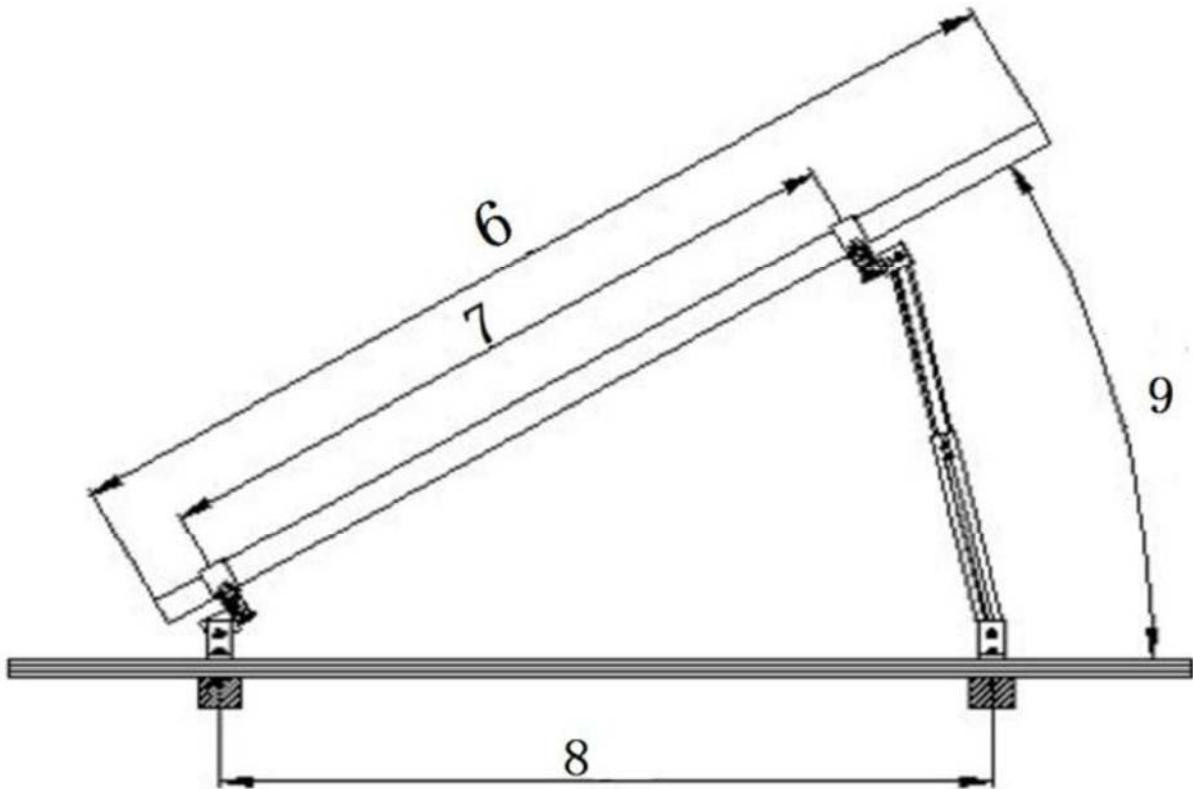
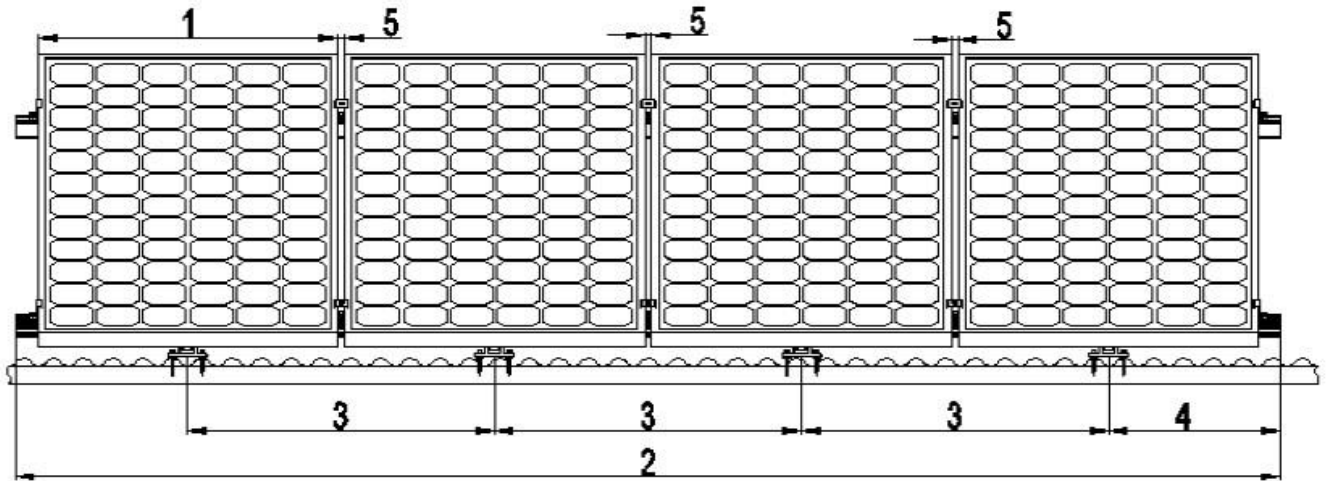

1. Width of the module
2. Length of Antaisolar Rail: number of modules horizontally x (width of the module + 17 mm) +70 mm
3. Distance between roof connections horizontally: Depending on the distance between rafters and on the static requirement.
4. Cantilever Length: less than half of dimension 3
5. Distance between modules: 17 mm
6. Length of the module
7. Length of support: similar with the dimension 8
8. Front and Rear Space: 1200~1400mm
9. Adjustable degree: 10-15deg / 15-30deg / 30-60deg

DETERMINE THE HEIGHT OF THE INSTALLATION SITE

This document provides sufficient information for Antaisolar system installation height less than 20 meters. If your installation site is more than 20 meters in height, please contact Antaisolar to obtain engineering data to support your installation.

VERIFY ACCEPTABLE RAIL END OVERHANG

Rail end overhang must equal 50 percent or less of foot spacing. Thus, if foot spacing is 1200mm, the Rail end overhang can be up to 600mm. In this case, two feet can support a rail of as much as 2400mm (1200mm between the feet and 600mm of overhang at each end).

DETERMINE ROOF SLOPE

Antaisolar mounting system can be used for roof slope up to 60 degrees. This document provides sufficient information for below 30 degrees, please contact Antaisolar for between 30 and 60 degrees.

DETERMINE THE MAXIMUM RAIL SUPPORT SPACING

Please use the table in certification of compliance to determine the Antaisolar Rail IV support spacing for installations. Certification of compliance please request from dealer or contact Antaisolar. Below only for reference.



Client: **Xlamen Antal New Energy Tech. Co., Ltd.**
 Project: **SolarRoof Interface Spacing Table**
 Address: **Within Australia**
 Designed: **B.C**

Job: **1850**
 Date: **Sep-15**

Tilt System Interface Spacing Table for Tin Roof							
Type of Rail		Rail IV					
Type of Interface		ATL-TYN-56					
Solar Panel Dimension		1640 mm x 992 mm					
Terrain category		3					
Tilt Angle (Φ) - 1° ≤ Φ < 15°							
Wind Region	Building Height - H (m)						
	H ≤ 10		10 < H ≤ 15		15 < H ≤ 20		
	Inter-mediate Zone	Internal	Inter-mediate Zone	Internal	Inter-mediate Zone	Internal	
A	1127	1313	1070	1246	1027	1196	
B	1047	1219	994	1157	954	1111	
C	572	858	497	746	446	669	
D	355	532	309	463	277	415	
Tilt Angle (Φ) - 15° ≤ Φ < 30°							
Wind Region	Building Height - H (m)						
	H ≤ 10		10 < H ≤ 15		15 < H ≤ 20		
	Inter-mediate Zone	Internal	Inter-mediate Zone	Internal	Inter-mediate Zone	Internal	
A	904	1053	858	999	824	959	
B	840	978	733	928	658	891	
C	285	427	248	372	222	333	
D	177	265	154	230	138	207	
Tilt Angle (Φ) - 30° ≤ Φ < 60°							
Wind Region	Building Height - H (m)						
	H ≤ 10		10 < H ≤ 15		15 < H ≤ 20		
	Inter-mediate Zone	Internal	Inter-mediate Zone	Internal	Inter-mediate Zone	Internal	
A	916	1157	796	1098	714	1054	
B	626	939	544	817	488	732	
C	211	317	184	276	165	247	
D	131	197	114	171	102	153	

INSTALLATION INSTRUCTION

Installation of Klamp Lock and fix foot

1. Mark the installation points of the clips according to your plans and the fixing spacing table in certification
Note: The EPDM rubber pad play the role of waterproof.

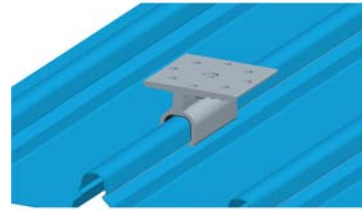

2. Place the fix foot on the Klamp Lock clips 700, and connect them by tightening 2 pcs M8 x 20 Bolt.
Note: Please make sure the clips are in a line.

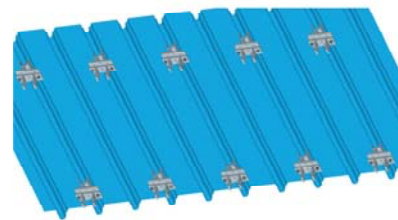
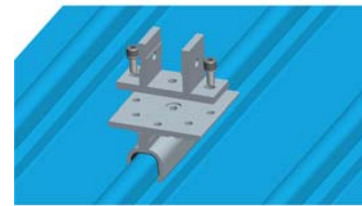

3. Install the Klamp Lock clips 406 and Fix foot as the installation of clips 700.

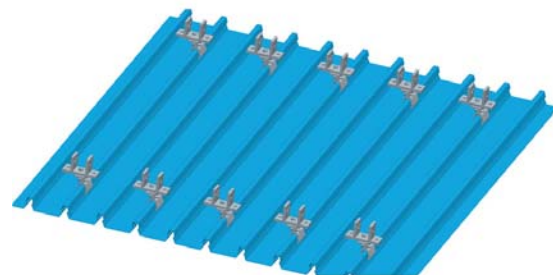

Install the front foot and rear leg

1. Determine the positions of the front foot and adjustable rear leg according to your plans and the fixing spacing table in certification.
2. Fix the front foot to the rafter using 2 pcs ST6.3*85 self-tapping screws.
3. Fix the rear leg to the rafter using 2 pcs ST 6.3*85 self-tapping screws.
4. Make sure the front foot and rear leg in a line.

Note: The EPDM rubber pad play the role of waterproof.

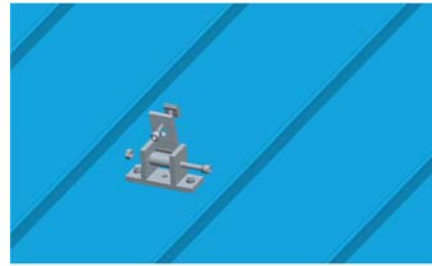

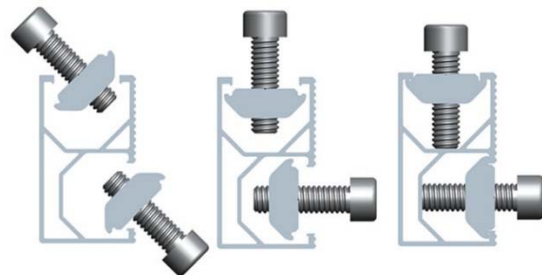

Install the Rail

- a. Tilt in the T module
Only Four steps to quick mount the tilt-in T-module into Antaisolar rail channel



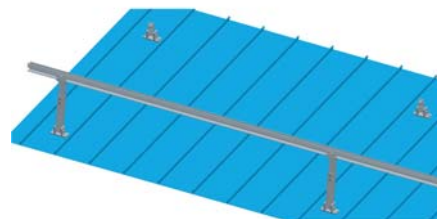



- b. Connect the rail
1. Insert the tilt-in module (Front foot) into the side channel of the Antaisolar rail as the step above shown.
 2. Adjust the rail to be level.
 3. Fasten the bolt.
- Note: Fasten firmly in place by torque bolt to 10Nm.

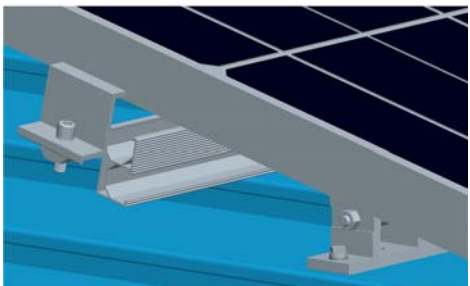
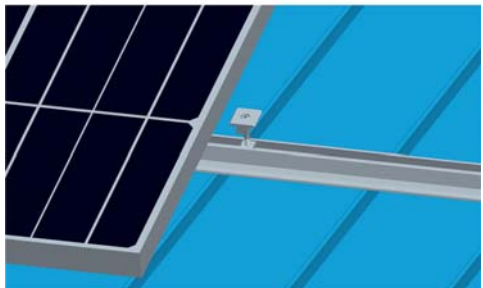

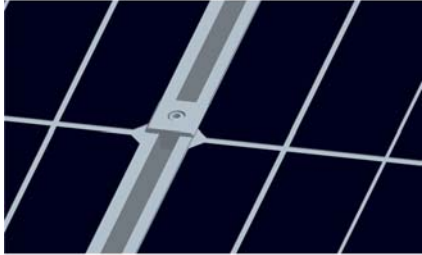
<p>c. Loosen the 2 Hex screws in the rear leg and adjust the length of rear legs as demanding angle. Install the rail with the rear leg as the step b.</p>	
<p>d. Connect the rail splice kits Install the splice to connect multiple rails together. Slide the splices on the rear side of the pre-assembled rails halfway to the side. Fasten the first M8 bolt firmly using the Allen key. Now slide the next rail segment into the splice. Tighten the second M8 bolt .The connection is finished.</p>	

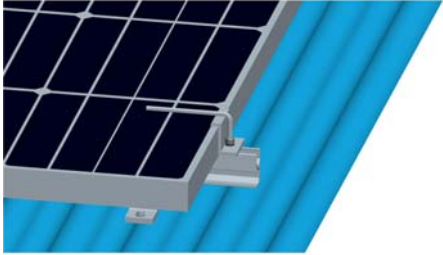
<h3>Install the module</h3>	
<p>a. Place the solar module on the rails, slide the end clamp tightly against the solar module and fasten tightly using the Allen bolt.</p>	
<p>b. Slide the pre-assembled inter clamp into the rails from above, place it firmly against the module and fasten loosely. Note: Install the grounding equipment as the next step</p>	

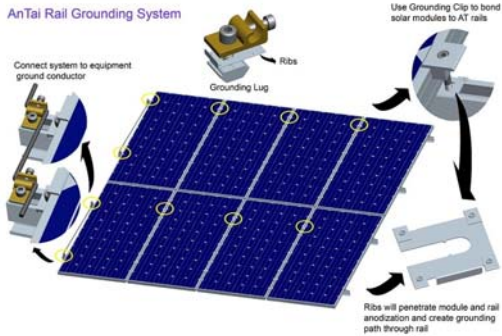
<p>c. Slide the next module against the previously installed module and tighten the inter clamp using the Allen key, Take care that the anti-slip protection sits in the rail channel of the lowest row of rails.</p>	
<p>d. Slide the next module against the previously installed module and tighten the inter clamp using the Allen key, Take care that the anti-slip protection sits in the rail channel of the lowest row of rails.</p>	
<p>d. Place the last module in the row on the rails (with the first row of modules, take care that the anti-slip protection sits properly in the rail channel) and fasten the last mid clamp and the end clamp using the Allen key.</p>	
<p>e. Leg Strut and fix foot can be adjusted.</p>	
<p>Antaisolar rail grounding system</p>	

WARRANTY

In so far as Xiamen Antai New Energy Tech. Co., Ltd. (Hereafter called Antaisolar) grants the customer a 10 year warranty to solar mounting systems, except for the anodized finish, which finish shall be free from visible peeling, or cracking or chalking under normal atmospheric conditions for a period of five (5) years. The Warranty Start Date is the date of delivery of the Product(s) to the Buyer or 2 months after the date of Product(s) dispatch from Antaisolar manufacturing site, whichever date is earlier.

Warranted Products

All anodized aluminum products and stainless steel 304 components in the solar mounting systems.

Exclusions and Limitations

In the event that damage is caused to a purchased item, despite proper installation and handling and in the context of normal use and maintenance, Antaisolar will immediately exchange the respective component within the warranty period. The following terms shall apply

1. Failure to comply with Antaisolar's installation manual;
2. Service by service technicians who are not qualified under the relevant law and/or applicable regulations at the place of installation;
3. The warranty period for each component defined in the respective product sheet by Antaisolar shall apply. The warranty period commences with the transfer of risk of the respective component; if, for particular components, generally or for a particular type of use a possible shorter life is expressly indicated within Antaisolar's individually-generated plans, an exchange is scheduled within a shorter period, the warranty period shall be restricted to such life or period.
4. The warranty is limited to additional delivery for the defective components upon notification of the damage within the warranty period. Any statutory guarantee or liability claims shall remain unaffected.
5. The obligation to fulfill the warranty shall not apply if the damage has arisen in connection with exceptional stress (e.g. storm damage, impact of instability of the sub-surface, particular chemical or biological effects). Or in such conditions, accident, force of nature (such as lightning strike, earthquake), influence from chemical products or other acts beyond Antaisolar's reasonable control (including damage by fire, flood, etc.)
6. With regard to installation and handling, the technical product descriptions and installation instructions regarding the respective products as supplied by us shall apply, as shall the statutory and generally-recognized standards and principles of building and construction work in local market as well as, as appropriate, on a priority basis, the plans, statics and instructions prepared by us individually for the customer.
7. No claims shall exist if the damage is covered or can usually be covered by insurance against storm and similar events (natural-peril insurance).
8. This warranty shall only be applied to solar mounting systems designed by Antaisolar. Custom design products if suggestions by Antaisolar are declined, this product is excluded in this warranty.
9. This warranty shall only establish claims of Antaisolar's customer, via which all warranty claims are to be settled. Assertion by third parties shall only be possible if Antaisolar agrees thereto.
10. Limited Warranty does not apply to any Products which have been subjected to use of the Products in

such a manner as to infringe Antaisolar's or any third party's intellectual property rights (e.g. patents, trademarks).

Repair, Replacement or Refund Remedy

1. As Buyer's sole and exclusive remedy under this Limited Warranty (though Buyers should note paragraph 4 below regarding the potential existence of other statutory rights), Antaisolar will, in its sole discretion, either, with regard to the applicable Product (or component thereof in the case of Mounting Product):

- a) refund the historical purchase price of the relevant Product(s); or
- b) repair the defective Product(s) at no charge (subject to the following paragraph); or
- c) replace the defective Product(s) or part thereof by a new or remanufactured equivalent at no charge (subject of the following paragraph).

In the event that Antaisolar opts for options b) or c), Antaisolar shall bear all insurance and transportation charges (except air freight, courier freight), customs clearance and any other costs for returning the defective Product(s) to Antaisolar and shipping the repaired or replaced Product(s) to Buyer (a Buyer may claim reimbursement by Antaisolar for these charges by contacting Antaisolar and providing proof to Antaisolar that these charges were incurred, e.g. an invoice from the relevant service provider). The costs and expenses for their removal, installation or reinstallation shall remain with Buyer.

2. The warranty period(s) shall not extend or renew upon the repair or replacement of a defective Product by Antaisolar. The warranty period for replaced or repaired Product(s) is the remainder of the warranty on the original new Product(s).

3. All other claims under this Limited Warranty against Antaisolar shall be excluded. Under this Limited Warranty, Antaisolar is not responsible for any special, incidental or consequential damages (including loss of profits, harm to goodwill or business reputation, or delay damages) whether such claims are based in contract, warranty, negligence or strict tort. This exclusion applies to the extent permissible by law, and even if the remedies set forth below herein are deemed to have failed of their essential purpose.

Rights and Remedies against Third Parties

This Limited Warranty shall be construed as a separate warranty and independent from any other contractual arrangement with third parties relating to the Product(s). It shall not affect any rights, obligations and remedies of the Buyer, if any, with regard to third parties for defects or non-conformity or non-compliance of the Products, notwithstanding its legal basis. The rights and remedies provided hereunder are in addition to any other rights and remedies against third parties to which Buyer may be entitled by agreements with such third parties or by law.

Claims Procedure, Notice Periods, Expiration of Warranty Claims and Limitations

1. Buyer shall notify Antaisolar immediately after discovery of any claim under this Limited Warranty by letter, facsimile or e-mail specifying each alleged claim including evidence of the claims and the serial numbers of the Product(s) at issue.
2. Any claim for breach of this Limited Warranty must be brought within three (1) months after discovery of the breach.

3. The return of any defective Product(s) will not be accepted unless prior written authorization has been given by Antaisolar.

Force Majeure

Antaisolar shall not be responsible or liable in any way to the Buyer for any non-performance or delay in performance under this Limited Warranty due to occurrences of force majeure such as, war, riots, strikes, unavailability of suitable and sufficient labor, material, or capacity or technical or yield failures and any unforeseen event beyond its control, including, without limitation, any technological or physical event or condition which is not reasonably known or understood at the time of the sale of the defective Product(s) or the notification of the relevant warranty claim under this Limited Warranty.

Warranty Assignment

This Limited Warranty is only applied when the Products remain installed in their original installation location.

Validity

This Limited Warranty shall apply to Product(s) manufactured after 1st January 2014. This Limited Warranty shall be valid until a new revision is issued by Antaisolar.

No other Warranty

Unless modified in a writing signed by an officer of Antaisolar, the Limited Warranty set forth herein is the only express warranty (whether written or oral) by Antaisolar applicable to the Products and no one is authorized to restrict, expand or otherwise modify this Limited Warranty.

Miscellaneous

If any provision of this Limited Warranty is held invalid, unenforceable or contrary to law then the validity of the remaining provisions of this Limited Warranty shall remain in full force and effect.

MAINTENANCE AND CLEANING

6005-T5 anodized aluminium is largely maintenance free. Only in highly polluted or marine conditions is rinsing with clean water required, during scheduled panel cleaning.

REFERENCES

AS/NZS 1170.2:2011/Amdt 3:2012 on wind actions

AS/NZS16641.1:1997 on aluminium structures

AS1720.1:2012 on timber structures

AS/NZS4600:2005 on cold-formed steel structures

AS3566-2011, self-drilling screws for the building and construction industries.

CONTACT DETAILS:

Xiamen Antai New Energy Tech. Co., Ltd.

Address: Room 402, No.21 Wanghai Road, Software Park II Siming District, Xiamen, China 361008

Tel: +86 592 5902557

Fax: +86 592 5508270

Email: info@antaisolar.com

APPENDIXES:

- Array Frame Engineering Certificate - Tilt Mount
- Array Frame Engineering Certificate - Tilt Mount with Kliplok Clamps

These Engineering Certificates contain important installation requirements. Please obtain these certification from your distributor.